



USER MANUAL

miRNAscope™ HD (RED) Assay

With Sample Preparation and Pretreatment

Document Number UM 324510

For Research Use Only. Not for diagnostic use.

Trademarks

RNAscope[®], BaseScope[™], miRNAscope[™], and HybEZ[™] are trademarks of Advanced Cell Diagnostics, Inc. VENTANA and DISCOVERY are trademarks of Roche. All other trademarks belong to their respective owners.

Citing RNAscope[®] in Publications

When describing a procedure for publication using this product, please refer to it as the RNAscope[®] Assay and cite: Wang F, Flanagan J, Su N, Wang L-C, Bui S, Nielson A, Wu X, Vo H-T, Ma X-J and Luo Y. RNAscope[®]: A Novel *In Situ* RNA Analysis Platform for Formalin-Fixed Paraffin-Embedded Tissues. *J. Mol. Diagnostics*, 2012, 14:22–29.

Disclaimers

Advanced Cell Diagnostics, Inc. reserves the right to change its products and services at any time to incorporate technological developments. This manual is subject to change without notice.

Although this manual has been prepared with every precaution to ensure accuracy, Advanced Cell Diagnostics, Inc. assumes no liability for any errors, omissions, or for any damages resulting from the use of this information.

Copyright

© 2020. Advanced Cell Diagnostics, Inc. All rights reserved.

Contents

Chapter 1. Product Information	6
About this guide.....	6
Product description.....	6
Background	6
Overview.....	6
Kit contents and storage.....	7
miRNAscope™ Probes.....	7
miRNAscope™ HD Assay Reagents.....	8
Required materials and equipment	9
HybEZ™ Hybridization System	9
User-supplied materials.....	9
Chapter 2. Before You Begin	11
Important procedural guidelines	11
Chapter 3. Prepare and Pretreat Samples.....	12
FFPE sample preparation and pretreatment	12
Workflow.....	12
Materials required.....	13
Prepare FFPE tissue sections.....	13
Bake slides	14
Deparaffinize FFPE sections.....	14
Post-fix samples	15
Prepare pretreatment materials	15
Apply RNAscope® Hydrogen Peroxide	16
Perform target retrieval using the Steamer	16
Create a barrier	17
Load the slides in the ACD EZ-Batch™ Slide Holder	17
Apply RNAscope® Protease III	18
Proceed to the miRNAscope™ Assay.....	19
Fixed-frozen tissue sample preparation and pretreatment.....	20
Workflow.....	20
Materials required.....	21
Fix samples	21
Freeze tissues	21
Prepare sections	22
Post-fix samples	22
Prepare pretreatment materials	23
Apply RNAscope® Hydrogen Peroxide	23
Perform target retrieval using the Steamer	23
Create a barrier	24
Apply RNAscope® Protease III	25
Proceed to the miRNAscope™ Assay.....	25
Fresh-frozen sample preparation and pretreatment.....	26

Workflow.....	26
Materials required.....	27
Prepare fresh-frozen tissue sections.....	27
Fix the sections	28
Dehydrate the sections.....	28
Create a hydrophobic barrier	28
Apply RNAscope® Hydrogen Peroxide	29
Apply RNAscope® Protease IV.....	29
Proceed to the miRNAscope™ Assay.....	29
Chapter 4. miRNAscope™ HD Assay	30
Workflow.....	30
Materials required for the assay	31
Prepare the materials	31
Prepare 1X Wash Buffer	31
Prepare counterstaining reagents	32
Equilibrate reagents	32
Run the assay.....	32
Hybridize probe	32
Hybridize Amp 1	33
Hybridize Amp 2	33
Hybridize Amp 3	33
Hybridize Amp 4	33
Hybridize Amp 5	34
Hybridize Amp 6	34
Detect the Red signal	34
Counterstain the slides	34
Mount the samples	35
Evaluate the samples	35
Scoring guidelines	35
Control example	36
Troubleshooting.....	36
Appendix A. Tissue Pretreatment Recommendation	37
Tissue pretreatment recommendation.....	37
Tissue-specific pretreatment conditions.....	37
Appendix B. Manual Target Retrieval.....	39
Materials required.....	39
Prepare 1X RNAscope® Target Retrieval Reagents	39
Apply RNAscope® Target Retrieval Reagents	39
Appendix C. Reagent Volume Guidelines.....	40
Determine reagent volume	40
Appendix D. Safety	41
Chemical safety	41
Biological hazard safety.....	41

Documentation and support	43
Obtaining SDSs	43
Obtaining support	43
Contact information	43
Limited product warranty	43

1

Chapter 1. Product Information



Before using this product, read and understand the information in **Appendix D. Safety** on page 41 in this document.

IMPORTANT! We recommend reading the entire user manual before beginning any protocols.

About this guide

This user manual provides guidelines and protocols to use the miRNAscope™ HD Reagent Kit – RED (Cat. No. 324500) on formalin-fixed, paraffin-embedded (FFPE), fresh-frozen, or fixed-frozen sections mounted on slides. miRNAscope™ Assays are compatible with a variety of sample types including tissue microarray (TMA) and cell samples.

Visit www.acdbio.com/technical-support/user-manuals to download a technical note for other sample types or contact support.acd@bio-techne.com for more information.

Product description

Background

The miRNAscope™ Assays use a novel and proprietary method of in situ hybridization (ISH) to visualize microRNAs (miRNAs), PIWI-interacting RNAs (piRNAs), short interfering RNAs (siRNAs), and antisense oligonucleotides (ASOs) with single cell resolution in samples mounted on slides. The assays are based on ACD's patented signal amplification and background suppression technology. miRNAscope™ Assays do not require the RNA-free environment used for traditional ISH and allow users to detect short RNA molecules with high specificity and sensitivity with minimal optimization.

Overview

See **Figure 1** on page 7 for an illustration of the assay, which can be completed in 8–10 hours or conveniently divided into two days. miRNAscope™ Assay reagents are provided in convenient Ready-To-Use dropper bottles allowing a simple, nearly pipette-free workflow.

Starting with properly prepared tissue samples, sections are first pretreated, and then short RNA-specific probes are hybridized to the target. The signal is amplified using a multi-step process, followed by hybridization to alkaline phosphatase (AP)-labeled probes and detected using a chromogenic substrate. Fast Red is used as a detection reagent, which enables short RNA molecules (17-50 nucleotides) to be visualized as red chromogenic dots under a common bright-field microscope. The miRNAscope™ HD Assay has additional amplification steps that allow observable results under 10–20X magnification.

Figure 1. Procedure overview

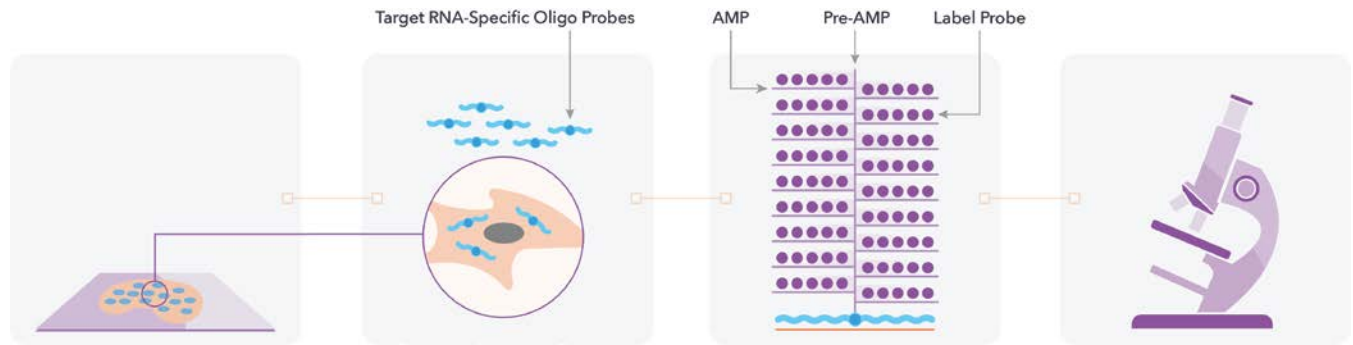

1: Tissue section	2: Hybridize to target RNA	3: Amplify signal	4: Image
Start with properly prepared tissue sections and pretreat to allow access to target RNA.	Hybridize gene-specific probe to target short RNA.	Use signal amplification systems to detect target short RNA. Probes are hybridized to a cascade of signal amplification molecules, culminating in binding of AP-labeled probes. Add chromogenic substrates to detect RNAs.	Visualize target RNA using a standard bright-field microscope.

Kit contents and storage

The miRNAscope™ HD Assays require miRNAscope™ HD Probes and miRNAscope™ HD Reagent Kits. Probes and reagent kits are available separately.

miRNAscope™ Probes

The miRNAscope™ HD Probes consist of the user-specified Target Probe and the Positive and Negative Control Probes. Visit <https://acdbio.com/products> to find a gene-specific target probe. Visit <http://www.acdbio.com/control-slides-and-probes> to order appropriate control probes. Each probe is sufficient for staining ~20 sections, each with an area of approximately 20 mm x 20 mm (0.75" x 0.75"). Larger tissue sections will result in fewer tests. The probes have a shelf life of two years from the manufacturing date when stored as indicated in the following tables:

IMPORTANT! For the assay to work properly, you must warm the miRNAscope™ HD Probes for **15 MIN** at **40°C** then cool them to room temperature before use.

Target Probes					
<input checked="" type="checkbox"/>	Reagent	Cat. No.	Content	Quantity	Storage
	miRNAscope™ Singleplex Target Probe	Various	Probe targeting specific RNA	3 mL x 1 bottle	2–8°C

Control Probes					
<input checked="" type="checkbox"/>	Reagent	Cat. No.	Content	Quantity	Storage
	miRNAscope™ Positive Control Probe-SR-RNU6-S1	727871-S1	Probe targeting common housekeeping gene	3 mL x 1 bottle	2–8°C
	miRNAscope™ Negative Control Probe-SR-Scramble-S1	727881-S1	Scramble probe	3 mL x 1 bottle	2–8°C

miRNAscope™ HD Assay Reagents

Each miRNAscope™ HD Reagent Kit –RED (Cat. No. 324500) provides enough reagents to stain ~20 tissue sections, each with an area of approximately 20 mm x 20 mm (0.75" x 0.75"). Larger tissue sections will result in fewer tests. Each kit contains Pretreatment Reagents, Target Retrieval Reagents, Wash Buffer Reagents, and Detection Reagents.

The reagents have a shelf life of nine months from the manufacturing date when stored as indicated in the following tables:

Pretreatment Reagents (Cat. No. 322380)			
<input checked="" type="checkbox"/>	Reagent	Quantity	Storage
	RNAscope® Hydrogen Peroxide	3 mL x 2 bottles	2–8°C
	RNAscope® Protease Plus	4.5 mL x 1 bottle	2–8°C
	RNAscope® Protease III	4.5 mL x 1 bottle	2–8°C
	RNAscope® Protease IV	4.5 mL x 1 bottle	2–8°C
	RNAscope® Target Retrieval (10X)	70 mL x 4 bottles	Room temperature (15–30°C)
miRNAscope™ HD Detection Kit-RED (Cat. No. 324500)			
<input checked="" type="checkbox"/>	Reagent	Quantity	Storage
	miRNAscope™ HD Amp 1	3 mL x 1 bottle	2–8°C
	miRNAscope™ HD Amp 2	4.5 mL mL x 1 bottle	2–8°C
	miRNAscope™ HD Amp 3	3 mL x 1 bottle	2–8°C
	miRNAscope™ HD Amp 4–Red	4.5 mL mL x 1 bottle	2–8°C
	miRNAscope™ HD Amp 5–Red	4.5 mL mL x 1 bottle	2–8°C
	miRNAscope™ HD Amp 6–Red	3 mL x 1 bottle	2–8°C
	miRNAscope™ HD Fast Red-A	3 mL x 1 bottle	2–8°C
	miRNAscope™ HD Fast Red-B	3 mL x 1 bottle	2–8°C
miRNAscope™ HD Detection Kit-RED (Cat. No. 324500)			
<input checked="" type="checkbox"/>	Reagent	Quantity	Storage
	50X Wash Buffer	60 mL x 4 bottles	Room temperature (15–30°C)

IMPORTANT! miRNAscope™ HD Reagent Kits share the same Wash Buffer and pretreatment reagents as RNAscope® 2.5 HD Reagent Kits, but has a unique Detection Kit. Do not interchange the reagent components of the Detection Kits, even those having the same name.

Required materials and equipment

The following materials and equipment are needed to perform the miRNAscope™ HD Assay.

HybEZ™ Hybridization System

IMPORTANT! The miRNAscope™ HD Assay has been qualified using this system only.

Use the HybEZ™ II Hybridization System to perform miRNAscope™ HD Assay hybridization and incubation steps. These steps require humid conditions to prevent sections from drying out.

For instructions on how to use the HybEZ™ II Hybridization System, refer to the *HybEZ™ II Hybridization System User Manual* (Doc. No. 321710-USM) available at www.acdbio.com/technical-support/user-manuals and view the training video at www.acdbio.com/technical-support/learn-more. The system contains the following components:

<input checked="" type="checkbox"/>	Component	Quantity	Cat. No.
	HybEZ™ II Oven (110 or 220 VAC)	1 oven	321710 or 321720 (HybEZ™ II)
	HybEZ™ Humidity Control Tray (with lid)	1 tray	310012
	ACD EZ-Batch™ Wash Tray	1 tray	321717
	ACD EZ-Batch™ Slide Holder	1 holder	321716
	HybEZ™ Humidifying Paper	2 sheets	—

Note: To order HybEZ™ Humidifying Paper Pack, 15 sheets, use Cat. No. 310015

User-supplied materials

IMPORTANT! Do not substitute other materials for the ImmEdge™ Hydrophobic Barrier Pen, the SuperFrost® Plus Slides, and the EcoMount listed in the following table.

<input checked="" type="checkbox"/>	Description	Supplier	Cat. No.
	ImmEdge™ Hydrophobic Barrier Pen (required)	Vector Laboratory	H-4000
	SuperFrost® Plus Slides (required)	Fisher Scientific	12-550-15
	Gill's Hematoxylin I	American Master Tech Scientific/MLS*	HXGHE1LT
	Xylene	Fisher Scientific/MLS	X3P-1GAL
	10% Neutral Buffered Formalin (NBF)/ 4% Paraformaldehyde (PFA) / 37% Formaldehyde	MLS Sigma	— 252549-1L
	1X Phosphate Buffered Saline (PBS)	MLS	—
	Tissue-Tek® Vertical 24 Slide Rack	American Master Tech Scientific/MLS	LWSRA24
	Tissue-Tek® Staining Dishes	American Master Tech Scientific/MLS	LWT4457EA

☑	Description	Supplier	Cat. No.
	Tissue-Tek [®] Clearing Agent Dish, xylene resistant	American Master Tech Scientific/MLS	LWT4456EA
	100% alcohol (EtOH)	American Master Tech Scientific/ALREACS	—
	Paraffin wax	MLS	—
	Microtome	MLS	—
	Drying oven, capable of holding temperature at 60 +/- 1°C	MLS	—
	EcoMount (required)	Biocare	EM897L
	Cover glass, 24 x 50 mm	Fisher Scientific/MLS	12--545-F
	Ammonium hydroxide, 28–30%	Sigma-Aldrich/MLS	320145-500mL
	Carboy (>3L)	MLS	—
	Oster [®] Steamer Model 5712, Black and Decker Steamer HS3000, the Braun Multiquick FS 20 Steamer, or the Hamilton Beach Steamer	—	—
	Aluminum foil (Optional)†	MLS	—
	Forceps, large (Optional)†	MLS	—
	Hot plate (Optional)†	MLS	—
	Water bath or incubator, capable of holding temperature at 40 +/- 1°C	MLS	—
	Pipettors and tips, 1–1000 µL	MLS	—
	Distilled water	MLS	—
	Tubes (various sizes)	MLS	—
	Fume hood	MLS	—
	Graduated cylinder	MLS	—
	Parafilm	MLS	—
	Paper towel or absorbent paper	MLS	—
	Microcentrifuge	MLS	—
	Microscope and accessories	MLS	—

* Major Laboratory Supplier in North America. For other regions, please check Catalog Numbers with your local lab supplier.

† Required for the alternate target retrieval method in Appendix B on page 39.

2

Chapter 2. Before You Begin

Prior to running the miRNAscope™ HD Assay on your samples for the first time, we recommend that you:

- View the video demonstrations available at www.acdbio.com/technical-support/learn-more.
- Run the assay on FFPE Control Slides (Cat. No. 310045 for Human control slide, HeLa; Catalog No. 310023 for Mouse control slide, 3T3) using the positive and negative control probes.

Important procedural guidelines

- Start with properly prepared sections. Refer to our sample preparation and pretreatment user guides available at www.acdbio.com/technical-support/user-manuals.
- Use only samples mounted on SuperFrost Plus® Slides (Fisher Scientific; Cat. No. 12-550-15).
- Follow the recommended pretreatment conditions for your sample. Refer to our sample preparation and pretreatment user guides available at www.acdbio.com/technical-support/user-manuals.
- Always run positive and negative control probes on your sample to assess sample RNA quality and optimal permeabilization.
- Do *not* substitute required materials. Assay has been validated with these materials only.
- Follow the protocol exactly for best results.
- Do not let your sections dry out during the procedure.
- Use good laboratory practices and follow all necessary safety procedures. Refer to **Appendix D. Safety** on page 41 for more information.

3

Chapter 3. Prepare and Pretreat Samples

This chapter describes three tissue sample preparation methods: formalin-fixed, paraffin-embedded (FFPE) sample preparation and pretreatment, fixed-frozen sample preparation and pretreatment, and fresh-frozen sample preparation and pretreatment. For other sample types and preparation methods, contact support.acd@bio-techne.com for the latest protocols and guidelines.

IMPORTANT! We highly recommend following these guidelines. We cannot guarantee assay results with other preparation methods.

FFPE sample preparation and pretreatment

For suboptimally prepared samples, you may need to optimize pretreatment conditions. Refer to **Appendix A. Tissue Pretreatment Recommendation** on page 37, and to <https://acdbio.com/technical-support/solutions>.

Workflow

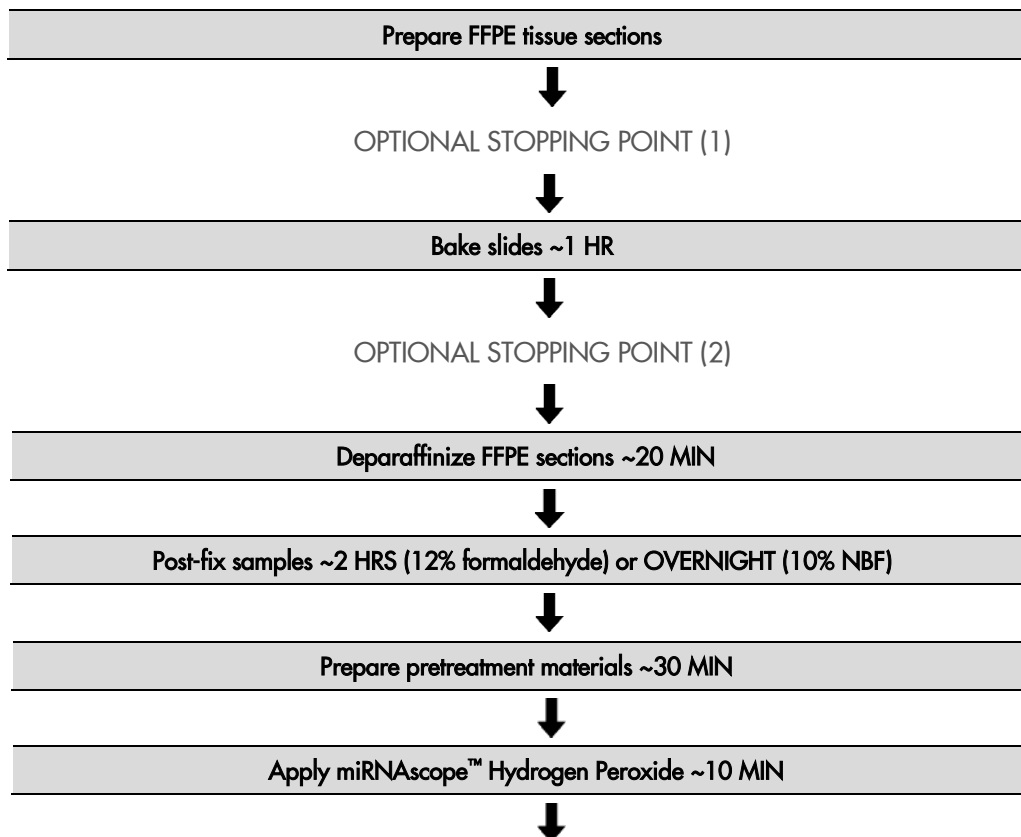

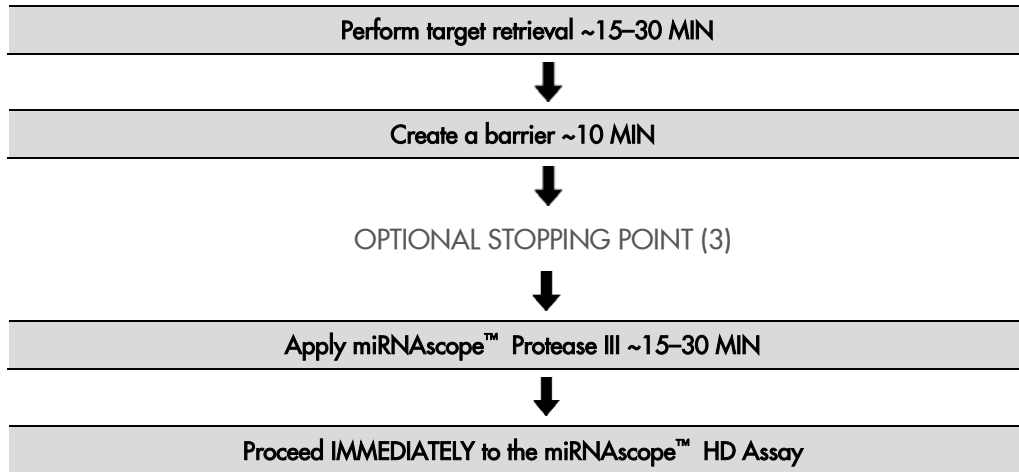

Materials required

Materials provided by Pretreatment Reagents (Cat. No. 322380)	Other Materials and Equipment
<ul style="list-style-type: none"> • RNAscope® Hydrogen Peroxide • RNAscope® Protease III or Protease Plus (depending on sample-specific conditions) • RNAscope® 10X Target Retrieval Reagents 	<ul style="list-style-type: none"> • 10% Neutral Buffered Formalin (NBF) or 37% Formaldehyde • 1X PBS • Paraffin wax • Tissue-Tek® Clearing Agent Dishes • Tissue-Tek® Staining Dishes • Tissue-Tek® Vertical 24 Slide Rack • 100% alcohol (EtOH) • Xylene • Microtome • Water bath • SuperFrost® Plus slides • ImmEdge™ Hydrophobic Pen • Drying oven • Distilled water • Fume hood • HybEZ™ Humidifying System/ACD EZ-Batch™ Slide Holder and Wash Tray • Paper towel or absorbent paper • Steamer • Digital thermometer

Prepare FFPE tissue sections

1. Immediately following dissection, fix tissue in 10% NBF for **16–32 HRS** at **ROOM TEMPERATURE (RT)**. Fixation time will vary depending on tissue type and size.

 **CAUTION!** Handle biological specimens appropriately.

IMPORTANT! Fixation for **<16 HRS** or **>32 HRS** will impair the performance of the assay.

2. Wash sample with 1X PBS.
 3. Dehydrate sample using a standard ethanol series, followed by xylene.
-

IMPORTANT! Use fresh reagents.

4. Embed sample in paraffin using standard procedures.

Note: Embedded samples may be stored at room temperature with desiccants. To better preserve RNA quality over a long period (>1 yr), storing at 2–8°C with desiccants is recommended.

5. Trim paraffin blocks as needed, and cut embedded tissue into 5 +/- 1 µm sections using a microtome.
6. Place paraffin ribbon in a **40–45°C** water bath, and mount sections on **SUPERFROST® PLUS SLIDES**. Place tissue as shown below for optimal staining:

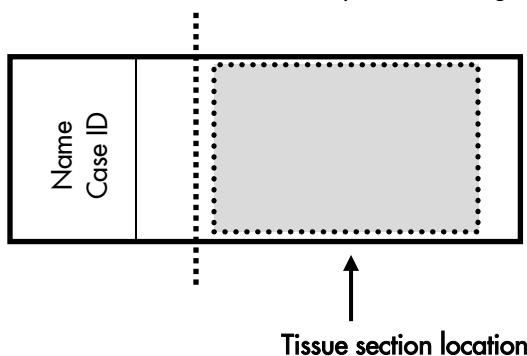

IMPORTANT! Do not mount more than one section per slide. Place sections in the center of the slide.

1. Air dry slides **OVERNIGHT** at **RT**.

OPTIONAL STOPPING POINT (1). You can store sections with desiccants at room temperature. Use sectioned tissue within three months.

Bake slides

1. Bake slides in a dry oven for **1 HR** at **60°C**.

OPTIONAL STOPPING POINT (2). Use immediately, or store at RT with desiccants for ≤1 week. Prolonged storage may degrade sample RNA.

Note: If you continue with the procedure, you can prepare materials for the next steps while the slides are baking.

Deparaffinize FFPE sections

Reagents may be prepared ahead of time. Ensure that all containers remain covered.

1. In a fume hood:
 - Fill two Tissue-Tek® Clearing Agent dishes with ~200 mL fresh xylene.
 - Fill two Tissue-Tek® Staining dishes with ~200 mL fresh 100% ethanol.

2. Place slides in a Tissue-Tek® Slide Rack and submerge in the first xylene-containing dish in the fume hood.
3. Incubate the slides in **xylene** for **5 MIN** at **RT**. Agitate the slides by occasionally lifting the slide rack up and down in the dish.
4. Remove the slide rack from the first xylene-containing dish, and *immediately* place in the second xylene-containing dish in the fume hood.
5. Incubate the slides in **xylene** for **5 MIN** at **RT** with agitation.
6. Remove the slide rack from the second xylene-containing dish, and *immediately* place in a dish containing 100% ethanol.
7. Incubate the slides in 100% ethanol for **2 MIN** at **RT** with agitation.
8. Remove the slide rack from the first ethanol -containing dish, and *immediately* place in the second ethanol -containing dish.
9. Incubate the slides in 100% ethanol for **2 MIN** at **RT** with agitation.
10. Remove the slides from the rack, and place on absorbent paper with the section face-up. Dry slides in a drying oven for **5 MIN** at **60°C** (or until completely dry).

Post-fix samples

IMPORTANT! For optimal performance of the miRNAscope™ Assay, you must post-fix your samples. Choose one of the following procedures:

Post-fixation with NBF

1. In a fume hood, fill a Tissue-Tek® Clearing Agent dish with ~200 mL fresh 10% NBF.
2. Place slides in a Tissue-Tek® Slide Rack and submerge them in the 10% NBF.
3. Incubate slides **OVERNIGHT (16–18 HRS)** at **RT**.
4. Remove slides from the 10% NBF and wash them for **2 MIN** in distilled water.
5. Dry slides for **5 MIN** at **60°C** or until completely dry.

Post-fixation with formaldehyde

1. In a fume hood, prepare 12% formaldehyde in a Tissue-Tek® Clearing Agent dish by combining 65 mL fresh 37% formaldehyde to 135 mL of 1X PBS.
2. Place slides in a Tissue-Tek® Slide Rack and submerge them in the 12% formaldehyde.
3. Incubate slides for **2 HRS** at **RT**.
4. Remove slides from the 12% formaldehyde and wash them for **2 MIN** in distilled water.
5. Dry slides for **5 MIN** at **60°C** or until completely dry.

Prepare pretreatment materials

1. Turn on the HybEZ™ Oven, and set the temperature to **40°C**.
2. Place a Humidifying Paper in the Humidity Control Tray and wet completely with distilled water.
3. Insert the covered tray into the oven and close the oven door. Warm the tray for **30 MIN** at **40°C** before use. Keep the tray in the oven when not in use.
4. Prepare 200 mL of fresh RNAscope® 1X Target Retrieval Reagents by adding 180 mL distilled water to 20 mL 10X Target Retrieval Reagents. Mix well

Apply RNAscope® Hydrogen Peroxide

1. Lay the deparaffinized slides on the bench and add ~5–8 drops of RNAscope® Hydrogen Peroxide to cover each section.
2. Incubate slides for **10 MIN** at **RT**.
3. Remove RNAscope® Hydrogen Peroxide solution from one slide at a time by tapping and/or flicking the slide on absorbent paper. Immediately insert the slide into a Tissue-Tek® Slide Rack submerged in a Tissue-Tek® Staining Dish filled with distilled water.
4. Wash slides 3–5 times by moving the Tissue-Tek® Slide Rack up and down in the distilled water.
5. Repeat Step 4 with fresh distilled water.

Perform target retrieval using the Steamer

IMPORTANT! Before you begin, make sure you know the pretreatment conditions specific to your sample type from **Appendix A. Tissue Pretreatment Recommendation** on page 37.

We highly recommend using an Oster® Steamer for target retrieval. For an alternate method, see **Appendix B. Manual Target Retrieval** on page 39.

Note: You may also steam with the Braun Multiquick FS-20 Steamer or Hamilton Beach Digital Food Steamer - 5.5 Quart. For each steamer, fill the water to the maximum level before starting and do not refill water during the steaming process.

1. Fill the water reservoir with cold tap water to the “HI” marking line.

IMPORTANT! Do not overfill.

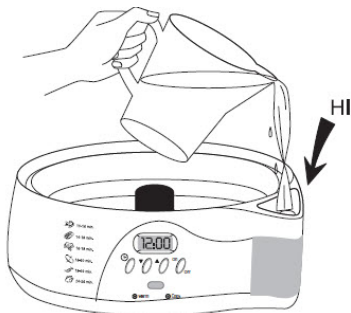

2. Place a clear Steaming Bowl onto the base.
3. Place two slide holders in the steam bowl. Fill one slide holder with 200 mL of RNAscope® 1X Target Retrieval Reagent. Fill the other slide holder with 200 mL of distilled H₂O.
4. Turn on the steamer. Set the steamer timer by turning the black knob clockwise. Set the heating time to **95 MIN**.
5. Insert a digital thermometer through the holes of the lid and into the container containing RNAscope® 1X Target Retrieval Reagent. Allow the temperature to rise to at least **99°C**.
6. Add the slides to the container containing distilled H₂O for **10 SEC** to acclimate the slides.
7. Remove the slides and move them to the container containing RNAscope® 1X Target Retrieval Reagent. Cover the steamer with the lid.
8. Start the timer for **15 MIN** for mild and standard conditions, and **30 MIN** for extended pretreatment. For pretreatment times, consult **Appendix A. Tissue Pretreatment Recommendation** on page 37.

9. Remove the slides from the steamer and transfer to a separate rinse container with 200 mL of distilled water. Allow the slides to rinse for **15 SEC**.
10. Transfer the slides to 100% ethanol for **3 MIN**.
11. Dry the slides in a **60°C** incubator (or at RT) for **5 MIN**.

Create a barrier

1. Use the following template to draw a barrier 2–4 times around each section with the ImmEdge™ hydrophobic barrier pen.

IMPORTANT! Do not let the barrier touch the tissue section. An ImmEdge™ hydrophobic barrier pen is highly recommended. Other pens may cause suboptimal results.

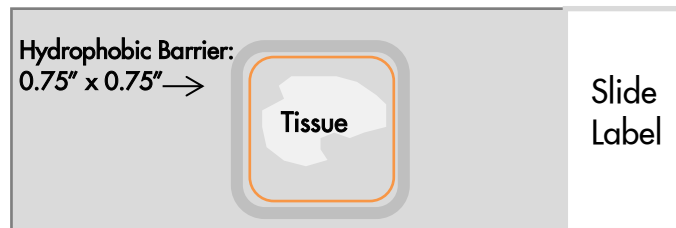

Note: We do not recommend drawing a smaller barrier and using less than the recommended volume amounts, even for smaller sections. Larger barriers will result in fewer tests per kit.

2. Let the barrier dry completely ~**5 MIN** or **OVERNIGHT** at **RT**.

Note: If you need to reapply the hydrophobic barrier during the following procedures, dry the appropriate area of the slide with a kimwipe. Do not touch the tissue section.

OPTIONAL STOPPING POINT (3). Dry slides overnight at room temperature for use the following day, or proceed directly to the next section.

Load the slides in the ACD EZ-Batch™ Slide Holder

The ACD EZ-Batch™ Slide Holder can hold up to 20 standard glass slides in secure, lock-down positions arranged in two parallel columns. Lock-down is achieved by two lockable swing clamps, one per column, along both sides of the slide holder. Clamp locking mechanisms are located at the slots found at one end of each clamp.

1. Open the swing clamps one at a time by simultaneously squeezing (pressing and holding) the slotted portion of each clamp and rotating it up then outwards, as shown.

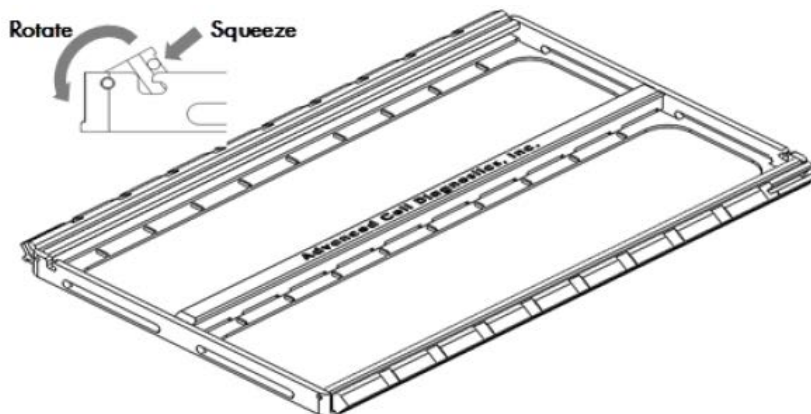

- Insert the slides one at a time into the holder (up to 10 slides per column). The non-label end of each slide should be aligned toward the center of the holder and inserted under the fixed clamp, as shown. Place the rest of the slide down into the holder.

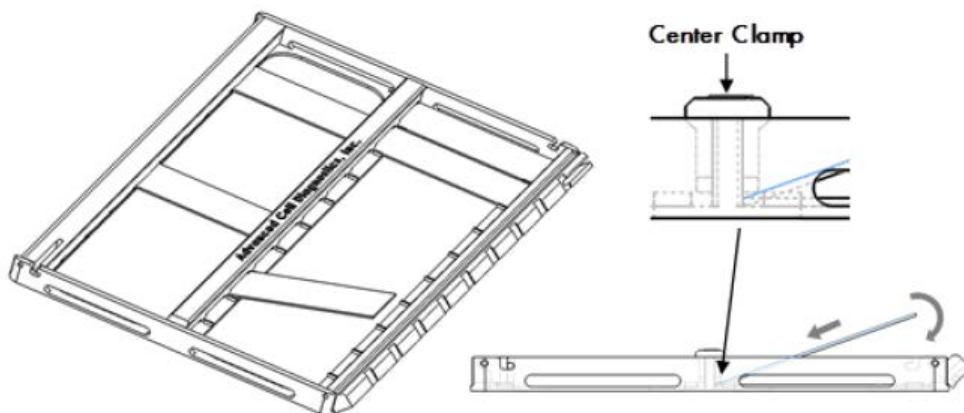

- Close and lock the swing clamp of the column by simultaneously squeezing the slotted portion of each clamp and rotating it in then downwards in the direction opposite to the direction used to open the clamp, as shown.

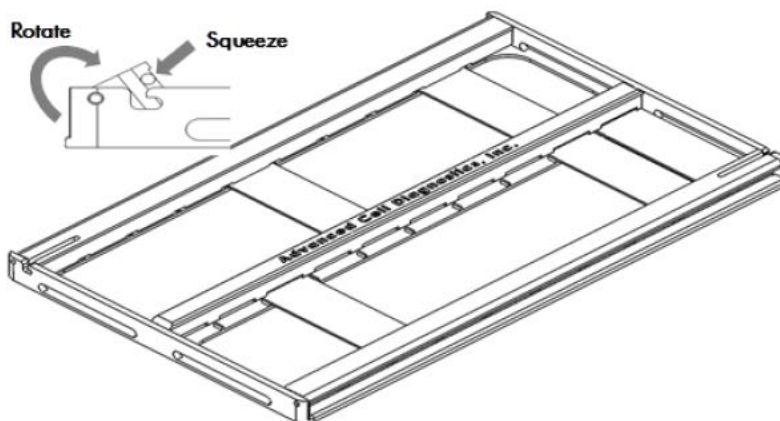

Apply RNAscope® Protease III

- Add ~5 drops of RNAscope® Protease III to entirely cover each section.
- Place the ACD EZ-Batch™ Slide Holder in the pre-warmed HybEZ™ Humidity Control Tray. Close the lid, seal, and insert the tray back into the oven.
- Incubate at **40°C** for the amount of time specified by the table in **Appendix A. Tissue Pretreatment Recommendation** on page 37.

Note: If needed, prepare miRNAscope™ Assay materials during this step.

- Pour at least 200 mL distilled water into the transparent ACDEZ-Batch™ Wash Tray.
- Remove the HybEZ™ Humidity Control Tray from the oven. Remove the slide holder from the tray. Place the tray back into the oven.
- Place the ACDEZ-Batch™ Slide Holder into the wash tray containing water. Make sure all the slides are submerged. If needed, carefully add more water. Wash the slides with slight agitation.

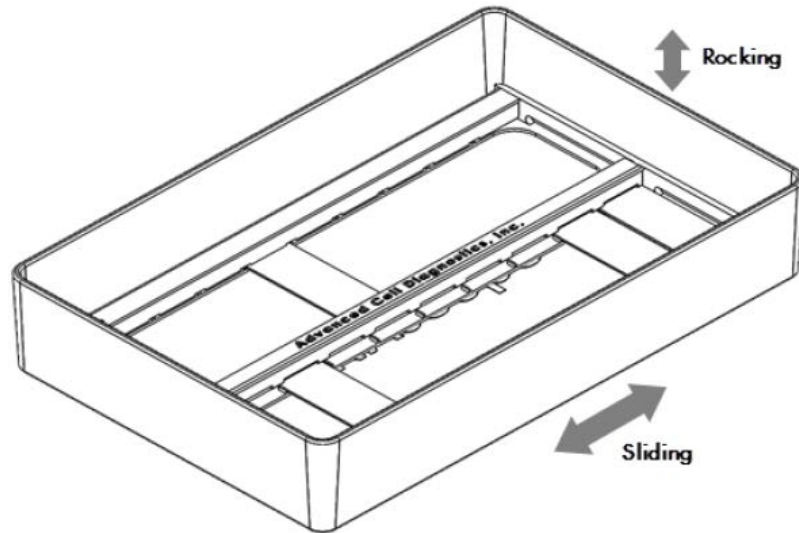

7. Repeat the wash step with fresh distilled water.

Proceed to the miRNAscope™ Assay

Proceed *immediately* to **Chapter 4. miRNAscope™ HD Assay** on page 30.

Fixed-frozen tissue sample preparation and pretreatment

For suboptimally prepared samples, you may need to optimize pretreatment conditions. Contact technical support at support.acd@bio-techne.com.

Workflow

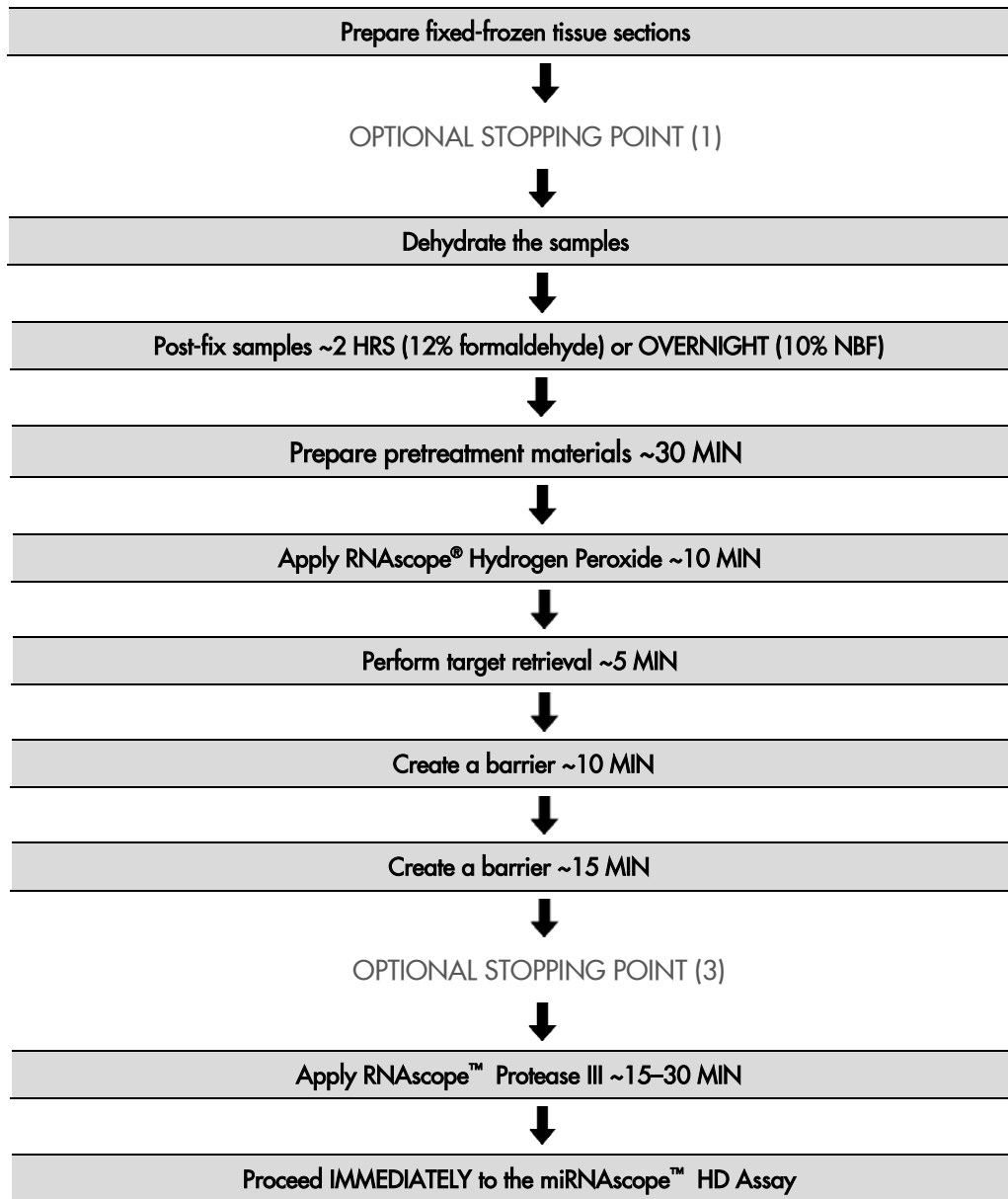

Materials required

Materials provided by Pretreatment Reagents (Cat. No. 322380)	Other Materials and Equipment
<ul style="list-style-type: none"> • RNAscope® Hydrogen Peroxide • RNAscope® Protease III or Protease Plus (depending on sample-specific conditions) • RNAscope® 10X Target Retrieval Reagents 	<ul style="list-style-type: none"> • Scalpel • Forceps • Cryo-embedding medium (OCT) • Dry ice, liquid nitrogen, or isopentane • Cryostat • Slide boxes • SuperFrost® Plus slides • Aluminum foil or zip-lock bags • 1X PBS • 10% Neutral Buffered Formalin (NBF) or 4% Paraformaldehyde (PFA) • 30% sucrose • Tissue-Tek® Vertical 24 Slide Rack • Tissue-Tek® Staining Dishes • ImmEdge™ Hydrophobic Barrier Pen • HybEZ™ Humidifying System/ ACD EZ-Batch™ Slide Holder and Wash Tray • Distilled water • Paper towel or absorbent paper • Steamer • Digital thermometer

Fix samples

1. If needed, perfuse the tissue with freshly prepared 4% paraformaldehyde (PFA) in 1X PBS, or go directly to Step 2.
2. Dissect the tissue and fix in freshly prepared 4% PFA for **24 HRS** at **4°C**.

Freeze tissues

1. Immerse the tissue in 10% sucrose in 1X PBS at **4°C** until the tissue sinks to the bottom of the container (approximately **18 HRS** for brain tissue).
2. Repeat this step with 20% sucrose in 1X PBS, followed by 30% sucrose in 1X PBS, each time allowing the tissue to sink to the bottom of the container.
3. Freeze the tissue in Optimal Cutting Temperature (OCT) embedding media or Tissue Freezing Media (TFM) using crushed dry ice, iso-pentane, or liquid nitrogen.
4. Store frozen tissue in an airtight container at **-80°C**.

Prepare sections

1. Before sectioning, equilibrate the tissue blocks at **-20°C** for at least **1 HR** in a cryostat.
2. Section the blocks by cutting 7–15 µm thick sections. Mount the sections on **SUPERFROST® PLUS SLIDES**. Place tissue as shown for optimal staining:

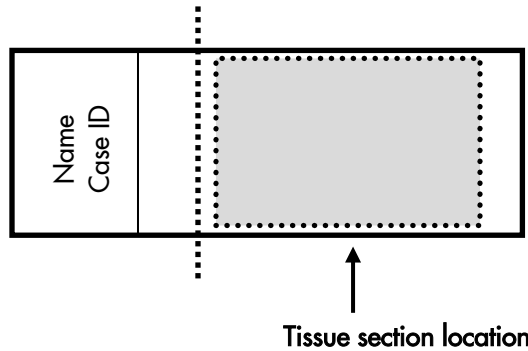

IMPORTANT! Do not mount more than one section per slide. Place sections in the center of the slide.

3. Air dry the slides for **60 –120 MIN** or **OVERNIGHT** at **-20°C**.

OPTIONAL STOPPING POINT (1). Use sectioned tissue within three months. Store sections with desiccants at **-80°C**.

4. Wash the slides with 200 mL 1X PBS in a Tissue-Tek® slide rack for **5 MIN** while moving the rack up and down to remove the embedding media.
5. Bake the slides for **1 HR** at **60°C**.
6. Post-fix the slides by immersing them in prechilled 10% NBF or 4% PFA in 1X PBS for **15 MIN** at **4°C**.

Dehydrate the tissue

1. Prepare 200mL 50% EtOH, 200 mL 70% EtOH, and 400 mL of 100% EtOH.
2. Remove the slides from the 10% NBF or 4% PFA and immerse them in 50% EtOH for **5 MIN** at **ROOM TEMPERATURE (RT)**.
3. Remove the slides from 50% EtOH, and immerse them in 70% EtOH for **5 MIN** at **RT**.
4. Remove the slides from 70% EtOH, and immerse them in 100% EtOH for **5 MIN** at **RT**.
5. Remove the slides from 70% EtOH, and immerse them in 100% EtOH for **5 MIN** at **RT**.
6. Remove the slides from 100% EtOH, and let them air dry for **5 MIN** at **RT**.

Post-fix samples

IMPORTANT! For optimal performance of the miRNAscope™ Assay, you must complete an additional post-fixation step. Choose one of the following procedures:

Post-fixation with NBF

1. In a fume hood, fill a Tissue-Tek® Clearing Agent dish with ~200 mL fresh 10% NBF.
2. Place slides in a Tissue-Tek® Slide Rack and submerge them in the 10% NBF.
3. Incubate slides **OVERNIGHT (16–18 HRS)** at **RT**.
4. Remove slides from the 10% NBF and wash them for **2 MIN** in distilled water.

5. Air dry slides for **5 MIN** at **60°C** or until completely dry.

Post-fixation with formaldehyde

1. In a fume hood, prepare 12% formaldehyde in a Tissue-Tek® Clearing Agent dish by combining 65 mL fresh 37% formaldehyde to 135 mL of 1X PBS.
2. Place slides in a Tissue-Tek® Slide Rack and submerge them in the 12% formaldehyde.
3. Incubate slides for **2 HRS** at **RT**.
4. Remove slides from the 12% formaldehyde and wash them for **2 MIN** in distilled water.
5. Air dry slides for **5 MIN** at **60°C** or until completely dry.

Prepare pretreatment materials

1. Turn on the HybEZ™ Oven, and set temperature to **40°C**.
2. Place a Humidifying Paper in the Humidity Control Tray and wet completely with distilled water.
3. Insert covered tray into oven and close the oven door. Warm the tray for **30 MIN** at **40°C** before use. Keep the tray in the oven when not in use.
4. Prepare 200 mL of fresh RNAscope® 1X Target Retrieval Reagents by adding 180 mL distilled water to 20 mL 10X Target Retrieval Reagents. Mix well.

Apply RNAscope® Hydrogen Peroxide

1. Add ~5–8 drops of RNAscope® Hydrogen Peroxide to each section and incubate for **10 MIN** at **RT**.
2. Remove RNAscope® Hydrogen Peroxide solution from one slide at a time by tapping and/or flicking the slide on absorbent paper. Immediately insert the slide into a Tissue-Tek® Slide Rack submerged in a Tissue-Tek® Staining Dish filled with distilled water.
3. Wash the slides 3–5 times by moving the Tissue-Tek® Slide Rack up and down in the distilled water.
4. Repeat Step 4 with fresh distilled water.

Perform target retrieval using the Steamer

We highly recommend using an Oster® Steamer for target retrieval. For an alternate method, see **Appendix B. Manual Target Retrieval** on page 39.

Note: You may also steam with the Braun Multiquick FS-20 Steamer or Hamilton Beach Digital Food Steamer - 5.5 Quart. For each steamer, fill the water to the maximum level before starting and do not refill water during the steaming process.

1. Fill the water reservoir with cold tap water to the “H1” marking line.

IMPORTANT! Do not overfill.

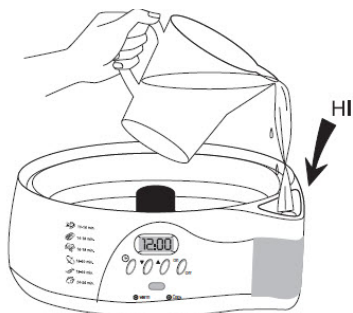

2. Place a clear Steaming Bowl onto the base.
3. Place two slide holders in the steam bowl. Fill one slide holder with 200 mL of RNAscope® 1X Target Retrieval Reagent. Fill the other slide holder with 200 mL of distilled H₂O.
4. Turn on the steamer. Set the steamer timer by turning the black knob clockwise. Set the heating time to **95 MIN**.
5. Insert a digital thermometer through the holes of the lid and into the container containing RNAscope® 1X Target Retrieval Reagent. Allow the temperature to rise to at least **99°C**.
6. Add the slides to the container containing distilled H₂O for **10 SEC** to acclimate slides.
7. Remove the slides and move them to the container containing RNAscope® 1X Target Retrieval Reagent. Cover the steamer with the lid.
8. Start the timer for **5 MIN** for mild and standard conditions.
9. Remove the slides from the steamer and transfer to a separate rinse container with 200 mL of distilled water. Allow the slides to rinse for **15 SEC**.
10. Transfer the slides to 100% alcohol for **3 MIN**.
11. Dry the slides in a **60°C** incubator (or at RT) for **5 MIN**.

Create a barrier

1. Use the following template to draw a barrier 2–4 times around each section with the ImmEdge™ hydrophobic barrier pen.

IMPORTANT! Do not let the barrier touch the tissue section. An ImmEdge™ hydrophobic barrier pen is highly recommended. Other pens may cause suboptimal results.

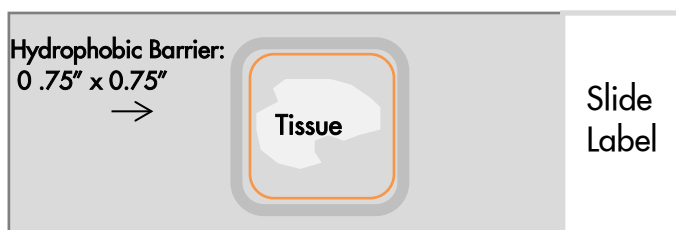

Note: We do not recommend drawing a smaller barrier and using less than the recommended volume amounts, even for smaller sections. Larger barriers will result in fewer tests per kit.

2. Let the barrier dry completely ~**5 MIN** or **OVERNIGHT** at **RT**.

Note: If you need to reapply the hydrophobic barrier during the following procedures, dry the appropriate area of the slide with a kimwipe. Do not touch the tissue section.

OPTIONAL STOPPING POINT (2). Dry slides overnight for use the following day, or proceed directly to the next section.

Apply RNAscope® Protease III

1. Load the dry slides into the ACD EZ-Batch™ Slide Holder by opening the swing clamp (see page 18 for detailed instructions).
2. Add ~5 drops of Protease III to each section. Use enough solution to completely cover the sections.
3. Remove the HybEZ™ Humidity Control Tray from the HybEZ™ Oven and place the ACD EZ-Batch™ Slide Holder in the tray. Close the lid, seal, and insert the tray back into the oven.
4. Incubate at **40°C** for the amount of time specified by the table in **Appendix A. Tissue Pretreatment Recommendation** on page 37.

Note: If needed, prepare miRNAscope™ Assay materials during this step.

5. Remove the HybEZ™ Humidity Control Tray from the oven. Remove the slide holder from the tray. Place the tray back into the oven.
6. Pour 200 mL distilled water into the transparent ACD EZ-Batch™ Wash Tray.
7. Place the ACD EZ-Batch™ Slide Holder containing the slides into the wash tray and wash the slides (see page 19 for details). Repeat the wash step with fresh water.

Proceed to the miRNAscope™ Assay

Proceed *immediately* to **Chapter 4. miRNAscope™ HD Assay** on page 30.

Fresh-frozen sample preparation and pretreatment

IMPORTANT! Do not apply RNAscope® Target Retrieval to fresh-frozen sections when using the RNAscope® Multiplex Fluorescent v2 Kit. Other sample types may need these treatments.

Workflow

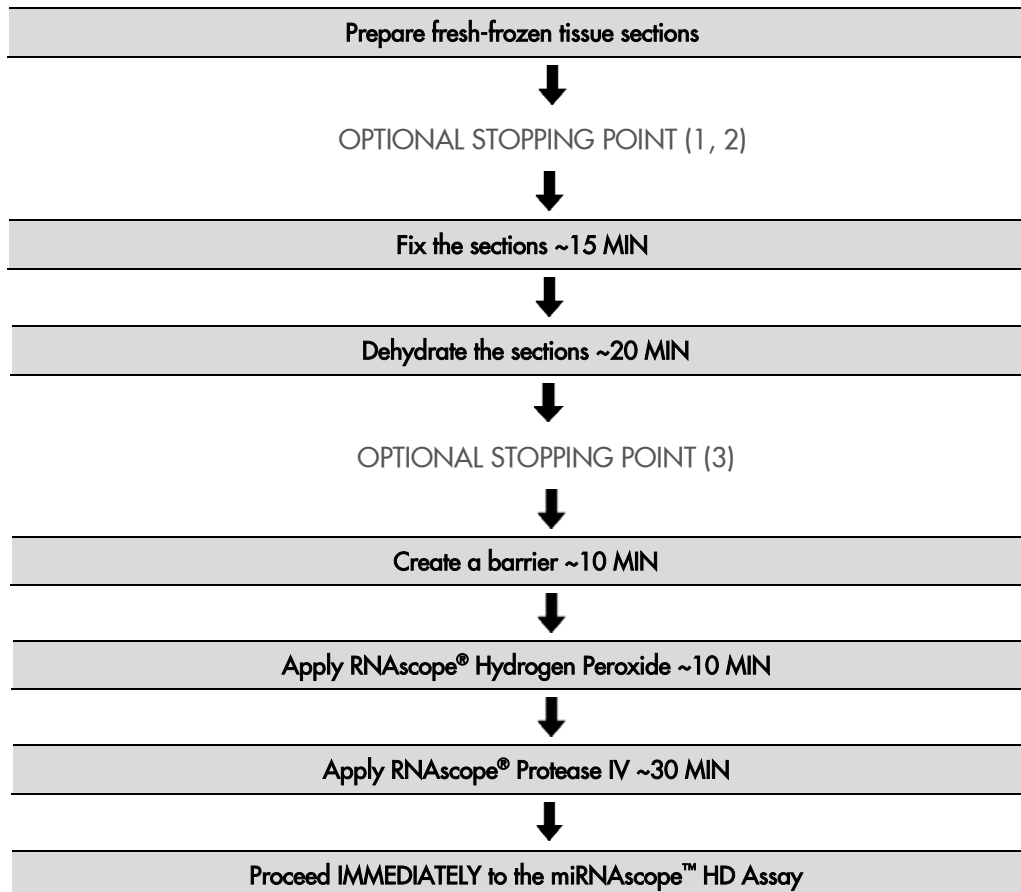

Materials required

Materials provided by Pretreatment Reagents (Cat. No. 322380)	Other Materials and Equipment
<ul style="list-style-type: none"> • RNAscope® Hydrogen Peroxide • RNAscope® Protease IV 	<ul style="list-style-type: none"> • Scalpel • Forceps • Cryo-embedding medium (OCT) • Dry ice, liquid nitrogen, or isopentane • Cryostat • Slide boxes • SuperFrost® Plus slides • Aluminum foil or zip-lock bags • 1X PBS • 10% neutral buffered formalin (NBF) or 4% paraformaldehyde (PFA) • 100% alcohol (EtOH) • Tissue-Tek® Vertical 24 Slide Rack • Tissue-Tek® Staining Dishes • ImmEdge™ Hydrophobic Barrier Pen • HybEZ™ Humidifying System/ ACD EZ-Batch™ Slide Holder and Wash Tray • Distilled water • Paper towel or absorbent paper

Prepare fresh-frozen tissue sections

1. Remove tissue and cut to fit into cryomolds.
2. Freeze the specimen on dry ice or in liquid nitrogen within **5 MIN** of tissue harvest.
3. Embed the frozen tissue in cryo-embedding medium (OCT):
 - a. Add two drops of OCT into a cryomold.
 - b. Place the frozen tissue on the OCT in the correct orientation for cutting.
 - c. Add more OCT to fill the cryomold. Do not allow any air bubbles to form.
 - d. Hold the block with forceps on the surface of the liquid nitrogen or isopentane cooled by dry ice or liquid nitrogen or place the cryomold on dry ice.
4. Store the frozen block in an air-tight container at **-80°C** prior to sectioning.

OPTIONAL STOPPING POINT (1). Embedded tissue may be stored for up to three months.

5. Section the block:
 - a. Equilibrate block to **-20°C** in a cryostat **~1 HR**.
 - b. Cut 10–20 µm thick sections and mount onto **SUPERFROST® PLUS SLIDES**.
 - c. Dry the sections at **60 –120 MIN** at **-20°C** to retain tissue adherence.
6. Store the sections in slide boxes wrapped air-tight with aluminum foil or zip-lock bags at **-80°C** until use.

IMPORTANT! Do not fix the slides prior to this step.

OPTIONAL STOPPING POINT (2). Sections may be stored for up to three months.

Fix the sections

1. Chill 200 mL 10% NBF (fresh 10% NBF or 4% PFA in 1X PBS) to 4°C in a Tissue Tek® Staining Dish.
2. Remove slides from -80°C and place in a Tissue Tek® Slide Rack.
3. *Immediately* immerse slides in the pre-chilled fixative. Fix for at least **1HR** at 4°C.

Note: Formalin that has been stored for more than six months, exposed to air for more than a week, or used repeatedly may result in suboptimal tissue fixation.

IMPORTANT! For some tissue types you may have to empirically determine the best duration for fixation

Dehydrate the sections

Reagents may be prepared ahead of time. Ensure all containers remain covered.

1. Prepare 200 mL 50% ethanol, 200 mL 70% ethanol, and 2X 200 mL 100% ethanol in Tissue Tek® Staining Dishes.
2. Place the slides in 50% ethanol for **5 MIN** at **ROOM TEMPERATURE (RT)**.
3. Place the slides in 70% ethanol for **5 MIN** at **RT**.
4. Place the slides in 100% ethanol for **5 MIN** at **RT**.
5. Place slides in fresh 100% ethanol for **5 MIN** at **RT**.

OPTIONAL STOPPING POINT (3). Slides may be stored in 100% ethanol at -20°C for up to one week. Prolonged storage may degrade sample RNA.

Create a hydrophobic barrier

1. Take slides out of 100% ethanol and place on absorbent paper with the section face-up. Air dry for **5 MIN** at **RT**.
2. Use the following template to draw a barrier 2–4 times around each section with the ImmEdge™ hydrophobic barrier pen.



Note: Refer to **Appendix C. Reagent Volume Guidelines** on page 40 to determine the recommended number of drops needed per slide.

IMPORTANT! Do not let the barrier touch the section. The ImmEdge™ hydrophobic barrier pen is highly recommended. Other pens may cause suboptimal results.

IMPORTANT! We do not recommend drawing a smaller barrier and using less than the recommended volume amounts, even for smaller sections. Larger barriers will result in fewer tests per kit.

3. Let the barrier dry completely ~**5 MIN** or **OVERNIGHT** at **RT**.

Note: If you need to reapply the hydrophobic barrier during the following procedures, dry the appropriate area of the slide with a Kimwipe®. Do not touch the tissue section.

Apply RNAscope® Hydrogen Peroxide

1. Add ~5–8 drops of RNAscope® Hydrogen Peroxide to each section and incubate for **10 MIN** at **RT**.
2. Remove RNAscope® Hydrogen Peroxide solution from one slide at a time by tapping and/or flicking the slide on absorbent paper. Immediately insert the slide into a Tissue-Tek® Slide Rack submerged in a Tissue-Tek® Staining Dish filled with distilled water.
3. Wash the slides 3–5 times by moving the Tissue-Tek® Slide Rack up and down in the distilled water.
4. Repeat Step 4 with fresh distilled water.

Apply RNAscope® Protease IV

5. Place the washed slides in the ACD EZ-Batch™ Slide Holder and add ~5 drops of Protease IV to each section. Use enough solution to completely cover the sections.
6. Incubate for **30 MIN** at **RT** in the HybEZ™ Humidity Control Tray.
7. Pour at least 200 mL 1X PBS into the transparent ACD EZ-Batch™ Wash Tray.
4. Place the ACD EZ-Batch™ Slide Holder containing the slides into the wash tray and wash the slides (see page 19 for details). Repeat the wash step with fresh 1X PBS.

IMPORTANT! If over-digestion is observed, first reduce the protease digestion time. Otherwise, use RNAscope® Protease III instead of RNAscope® Protease IV.

Proceed to the miRNAscope™ Assay

Proceed *immediately* to **Chapter 4. miRNAscope™ HD Assay** on page 30.

4

Chapter 4. miRNAscope™ HD Assay

This procedure flows directly from sample preparation and pretreatment. Refer to **Chapter 3. Prepare and Pretreat Samples** on page 12, or the appropriate sample preparation and pretreatment user manual or technical note for your specific sample type.

Workflow

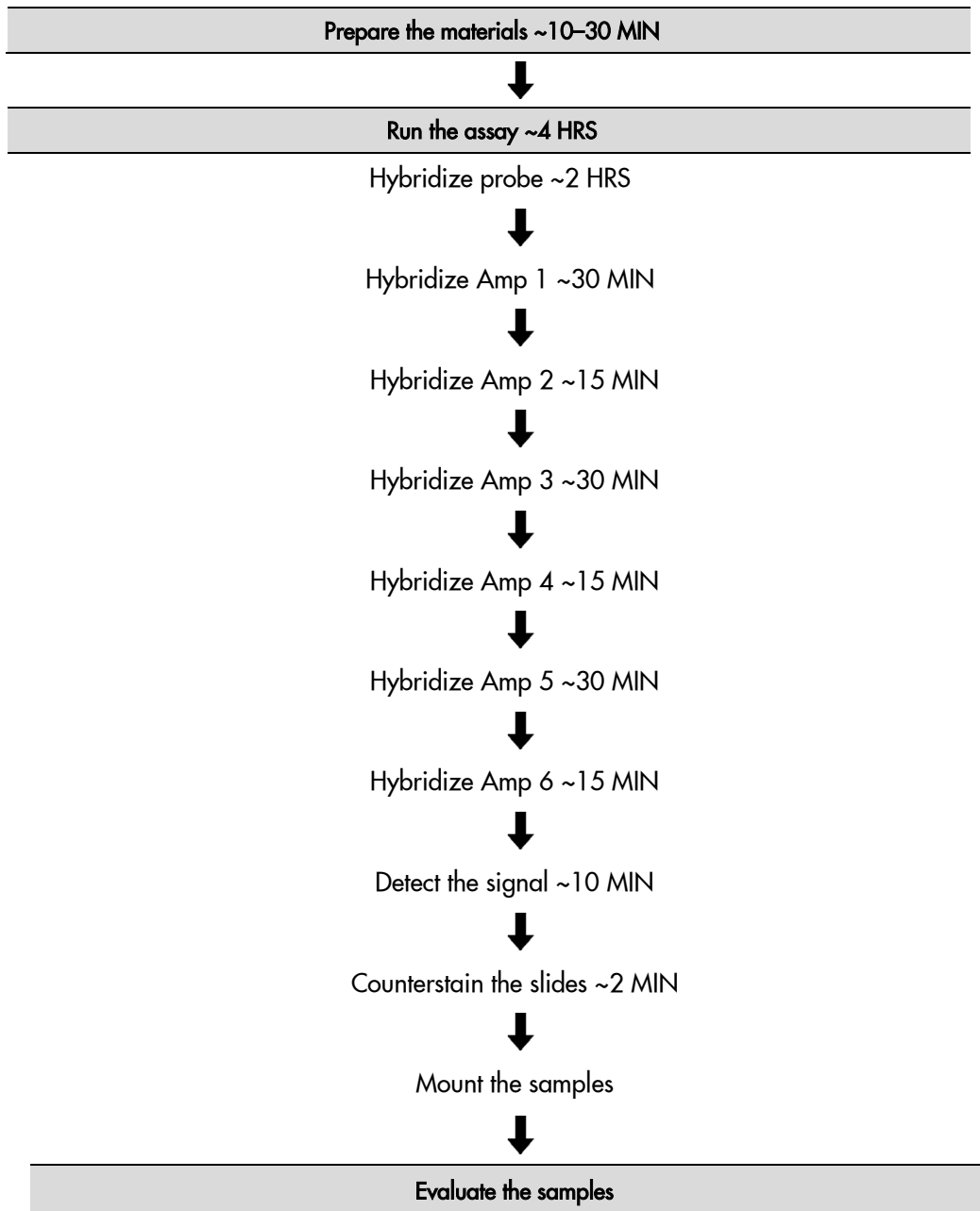

Materials required for the assay

Materials provided by the miRNAscope™ HD Reagent Kit – RED	Materials provided by miRNAscope™ Probes	Other materials and equipment
<ul style="list-style-type: none"> • RNAscope® Wash Buffer (50X) • miRNAscope™ HD Amp 1 • miRNAscope™ HD Amp 2 • miRNAscope™ HD Amp 3 • miRNAscope™ HD Amp 4– Red • miRNAscope™ HD Amp 5– Red • miRNAscope™ HD Amp 6– Red • miRNAscope™ Fast Red-A • miRNAscope™ Fast Red-B 	<ul style="list-style-type: none"> • Target Probe • Positive Control Probe • Negative Control Probe 	<ul style="list-style-type: none"> • Prepared sections • Distilled water • Carboy (>3L) • Fume hood • Xylene • Tissue-Tek® Staining Dish (3) • Tissue-Tek® Clearing Agent Dish, xylene-resistant (1) • Gill's Hematoxylin I • Ammonium hydroxide, 28–30% • Graduated cylinder • Parafilm • HybEZ™ Humidifying System/ACD EZ-Batch™ Slide Holder and Tray • Water bath or incubator • Tissue-Tek® Vertical 24 Slide Rack • Tubes (various sizes) • Paper towel or absorbent paper • Pipettors and tips, 1–1000 µL • Dry oven • EcoMount • Cover Glass, 24 mm x 50 mm

Prepare the materials

You may prepare the reagents at the same time you prepare pretreatment reagents. Some of the materials may be prepared in advance and stored at room temperature.

Prepare 1X Wash Buffer

- Prepare 3 L of 1X Wash Buffer by adding 2.94 L distilled water to 1 bottle of 50X Wash Buffer (60 mL) in a large carboy. Mix well.

Note: If precipitation occurs in the 50X Wash Buffer, warm it up at **40°C** for **10–20 MIN** before making the 1X Wash Buffer. 1X Wash Buffer may be prepared ahead of time and stored at room temperature for up to one month.

Prepare counterstaining reagents

1. In the fume hood, prepare 50% Hematoxylin staining solution by adding 100 mL Gill's Hematoxylin I to 100 mL distilled water in a staining dish.

Note: 50% Hematoxylin staining solution can be reused for up to 1 week.

2. In the fume hood, prepare 0.02% (w/v) Ammonia water (bluing reagent) by diluting the 28% Ammonium Hydroxide with distilled water in a graduated cylinder or other container.
3. Seal the cylinder with parafilm. Mix well 3–5 times.

Note: For assay quantitation, you must use Ammonium Hydroxide.

Equilibrate reagents

- Remove Amp 1–6 reagents from the refrigerator and place at **RT**.
- Ensure that the HybEZ™ Oven and prepared Humidity Control Tray are at **40°C**.
- Before each use, warm the Target and/or Control Probes for at least **10 MIN** at **40°C** in a water bath or incubator. Swirl gently to mix.

Run the assay

IMPORTANT! Do **NOT** let sections dry out between incubation steps. Work *quickly* and fill barrier with solutions.

IMPORTANT! View the wash step video at www.acdbio.com/technical-support/learn-more before proceeding.

Note: We recommend running control probes on your sample and optimizing the protocol before running any target probes.

Hybridize probe

IMPORTANT! Ensure that the probes are prewarmed and cooled to **RT** prior to use.

1. Remove excess liquid from the slides while keeping the slides locked in the ACDEZ-Batch™ Slide Holder. Insert the slide holder into HybEZ™ Humidity Control Tray.
2. Add ~4 drops of the appropriate probe to entirely cover each section.

Note: Refer to **Appendix A. Reagent Volume Guidelines** on page 40 to determine the recommended number of drops needed per slide. For example, add 4 drops of the appropriate probe for a 0.75" x 0.75" barrier.

3. Close the tray and insert into the oven for **2 HRS** at **40°C**.
4. Pour at least 200 mL 1X Wash Buffer into the transparent ACDEZ-Batch™ Wash Tray.
5. Remove the HybEZ™ Humidity Control Tray from the oven. Remove the slide holder from the tray. Place the tray back into the oven.
6. Place the ACDEZ-Batch™ Slide Holder into the wash tray (see page 19 for details), and wash the slides for **2 MIN** at **RT**. Repeat the wash step with fresh buffer.

Hybridize Amp 1

1. Remove excess liquid from the slides while keeping the slides locked in the ACDEZ-Batch™ Slide Holder. Insert the slide holder into the HybEZ™ Humidity Control Tray.
2. Add ~4 drops of Amp 1 to entirely cover each section.
3. Close the tray and insert into the HybEZ™ Oven for **30 MIN** at **40°C**.
4. Remove the HybEZ™ Humidity Control Tray from the oven. Remove the slide holder from the tray. Place the tray back into the oven.
5. Pour at least 200 mL 1X Wash Buffer into the transparent ACDEZ-Batch™ Wash Tray.
6. Place the ACDEZ-Batch™ Slide Holder into the wash tray (see page 19 for details), and wash the slides for **2 MIN** at **RT**. Repeat the wash step with fresh buffer.

Hybridize Amp 2

1. Remove excess liquid from the slides while keeping the slides locked in the ACDEZ-Batch™ Slide Holder. Insert the slide holder into the HybEZ™ Humidity Control Tray.
2. Add ~4 drops of Amp 2 to entirely cover each section.
3. Close the tray and insert into the HybEZ™ Oven for **15 MIN** at **40°C**.
4. Remove the HybEZ™ Humidity Control Tray from the oven. Remove the slide holder from the tray. Place the tray back into the oven.
5. Pour at least 200 mL 1X Wash Buffer into the transparent ACDEZ-Batch™ Wash Tray.
6. Place the ACDEZ-Batch™ Slide Holder into the wash tray (see page 19 for details), and wash the slides for **2 MIN** at **RT**. Repeat the wash step with fresh buffer.

Hybridize Amp 3

1. Remove excess liquid from the slides while keeping the slides locked in the ACDEZ-Batch™ Slide Holder. Insert the slide holder into the HybEZ™ Humidity Control Tray.
2. Add ~4 drops of Amp 3 to entirely cover each section.
3. Close the tray and insert into the HybEZ™ Oven for **30 MIN** at **40°C**.
4. Remove the HybEZ™ Humidity Control Tray from the oven. Remove the slide holder from the tray. Place the tray back into the oven.
5. Pour at least 200 mL 1X Wash Buffer into the transparent ACDEZ-Batch™ Wash Tray.
6. Place the ACDEZ-Batch™ Slide Holder into the wash tray (see page 19 for details), and wash the slides for **2 MIN** at **RT**. Repeat the wash step with fresh buffer.

Hybridize Amp 4

1. Remove excess liquid from the slides while keeping them locked in the ACDEZ-Batch™ Slide holder. Insert the slide holder into the HybEZ™ Humidity Control Tray
2. Add ~4 drops of Amp 4 to entirely cover each section.
3. Close the tray and insert into the HybEZ™ Oven for **15 MIN** at **40°C**.
4. Remove the HybEZ™ Humidity Control Tray from the oven. Remove the slide holder from the tray.

IMPORTANT! Do not insert the tray into the HybEZ™ Oven for the Amp 5 and Amp 6 incubations.

5. Pour at least 200 mL 1X Wash Buffer into the transparent ACDEZ-Batch™ Wash Tray.

6. Place the ACDEZ-Batch™ Slide Holder into the wash tray (see page 19 for details), and wash the slides for **2 MIN** at **RT**. Repeat the wash step with fresh buffer.

Hybridize Amp 5

1. Remove excess liquid from the slides while keeping them locked in the ACD EZ-Batch™ Slide holder. Insert the slide holder into the HybEZ™ Humidity Control Tray
2. Add ~4 drops of Amp 5 to entirely cover each section.
3. Close the tray and incubate the slides for **30 MIN** at **RT**.
4. Pour at least 200 mL 1X Wash Buffer into the transparent ACDEZ-Batch™ Wash Tray.
5. Place the ACD EZ-Batch™ Slide Holder into the wash tray (see page 19 for details), and wash the slides for **2 MIN** at **RT**. Repeat the wash step with fresh buffer.

Hybridize Amp 6

1. Remove excess liquid from the slides while keeping them locked in the ACD EZ-Batch™ Slide holder. Insert the slide holder into the HybEZ™ Humidity Control Tray.
2. Add ~4 drops of Amp 6 to entirely cover each section.
3. Close the tray and incubate the slides for **15 MIN** at **RT**.
5. Pour at least 200 mL 1X Wash Buffer into the transparent ACDEZ-Batch™ Wash Tray.
6. Place the ACDEZ-Batch™ Slide Holder into the wash tray (see page 19 for details), and wash the slides for **2 MIN** at **RT**. Repeat the wash step with fresh buffer.

Detect the Red signal

1. Briefly spin down the contents of the Fast Red-B tube to be sure the contents are at the bottom of the tube before opening the cap.
2. Depending on the size of your hydrophobic barrier, prepare sufficient Red working solution per section by using a 1:60 ratio of Fast Red -B to Fast Red -A. For example, for a 0.75" x 0.75" barrier, add 2 µL of Red -B to 120 µL of Red -A into a tube. Mix well.

IMPORTANT! Use the mixed Fast Red solution within **5 MIN**. Do not expose to direct sunlight or UV light.

3. Remove excess liquid from the slides while keeping them locked in the ACD EZ-Batch™ Slide holder. Insert the slide holder into the HybEZ™ Humidity Control Tray.
4. Pipette ~120 µL Red solution onto each tissue section. Ensure that the sections are covered.
5. Close the tray and incubate for **10 MIN** at **RT**.
6. Pour at least 200 mL 1X Wash Buffer into the transparent ACDEZ-Batch™ Wash Tray.
7. Place the ACDEZ-Batch™ Slide Holder into the wash tray (see page 19 for details), and wash the slides for **2 MIN** at **RT**. Repeat the wash step with fresh buffer.

Counterstain the slides

1. Move the slides into the staining dish containing 50% Hematoxylin staining solution for **2 MIN** at **RT**. Slides turn purple.
2. *Immediately* transfer the slide rack back into the staining dish containing tap water, and wash the slides 3–5 times by moving the rack up and down. Keep repeating with fresh tap water until the slides are clear, while the sections remain purple.

3. Replace the tap water in the staining dish with 0.02% Ammonia water. Move the rack up and down 2–3 times. The sections should turn blue.
4. Replace the Ammonia water with tap water. Wash the slides 3–5 times.

Mount the samples

1. Remove the slide rack from the staining dish and dry the slides in a **60°C** dry oven for at least **15 MIN** (until the slides are completely dry).

IMPORTANT! The Red substrate is alcohol sensitive. Do not dehydrate the slides in alcohol.

2. Briefly dip one slide into fresh pure xylene and immediately place 1–2 drops of EcoMount on the slide before the xylene dries.
3. Carefully place a 24 mm x 50 mm coverslip over the tissue section. Avoid trapping air bubbles.
4. Repeat steps 2 and 3 for each slide.
5. Air dry the slides for **≥5 MIN**.

Evaluate the samples

Examine tissue sections under a standard bright field microscope at 20–40X magnification:

- Assess tissue and cell morphology.
- Assess positive control signal strength. Positive control signal should be visible as punctate dots within cells at 20–40X magnification.
- Assess negative control background. No staining or less than one dot per cell displaying background staining per 20X microscope field is acceptable.
- Evaluate target probe signal using the scoring guidelines in the next section.

Scoring guidelines

The miRNAscope™ HD Assay enables a semi-quantitative scoring guideline utilizing the estimated number of punctate dots present within each cell boundary.

An example of how to develop such a guideline for semi-quantitative assessment of miRNAscope™ HD staining intensity is presented below for a gene with expression level varying between 1 to > 10 copies per cell.

Note: If your gene expression level is higher or lower than this range, you may need to scale the criteria accordingly.

Categorize staining into four grades: 0, 1, 2, and 3 according to the following table:

Staining Score	Microscope Objective Scoring*
0	No staining or less than 1 dot per cell (40X magnification)
1	2–10 dots/cell, no or very few cell clusters (40X magnification)
2	11–20 dots/cell and/or <25% dots are in clusters (20–40X magnification)
3	>20 dots/cell and/or >25% dots are in clusters (20X magnification)

* Discount cells with artificially high nuclear background staining.

Control example

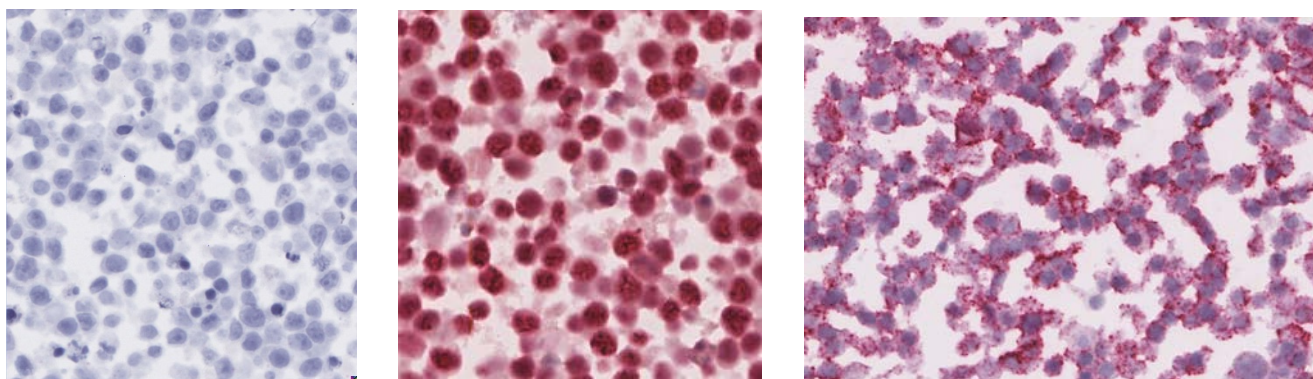

Scramble

Hs-RNU6

hsa-miR-205-5p

Figure 2. miRNAscope™ HD Detection Kit – RED performed on human liver cancer sections using the Scramble -S1 Negative Control Probe (Cat. No. 727881-S1) and Hs-RNU6-S1 Positive Control Probe (Cat. No. 727871-S1), 40X magnification. Detection of hsa-miR-205-5p in pancreatic cancer sections using hsa-miR-205-5p-S1 probe, 40X magnification.

Troubleshooting

For troubleshooting information, please contact technical support at support.acd@bio-techne.com.

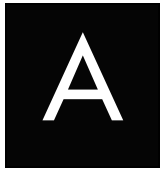

Appendix A. Tissue Pretreatment Recommendation

Follow the recommended pretreatment conditions based on your tissue type for:

- Any new or previously untested FFPE tissue types
- Samples prepared differently than the sample preparation protocol found in Chapter 3.

Tissue pretreatment recommendation

1. Stain representative samples using the positive and negative control probes.
2. Fix sample in fresh 10% NBF for **16–32 HRS** at **RT**.

Note: Perform tissue fixation step using the recommended amount of time. Over or under-fixation will result in significant signal loss when performing the miRNAscope™ HD Assay.

3. Depending on your tissue type, vary the amount of time for the RNAscope® Target Retrieval Reagents and/or RNAscope® Protease III (see the following section).

Reagent	Light	Mild	Standard	Extended
RNAscope® Target Retrieval Reagents	15 MIN	15 MIN	15 MIN	15–30 MIN
RNAscope® Protease III	15 MIN at RT	15 MIN at 40°C	30 MIN at 40°C	30 MIN at 40°C

Note: Some sample types, including certain xenografts and cell pellets, require less pretreatment time. For these tissue types, change the target retrieval time to **8 MIN** and use RNAscope® Protease III for **15 MIN** at **RT**. For the ACD Cell Pellet sample, we recommend using the mild conditions listed in the table. If you have a tissue type not listed, contact support at support.acd@bio-techne.com.

Tissue-specific pretreatment conditions

If your sample fixation is successful in fresh 10% NBF (Step 2 above), then refer to the following table for tissue-specific pretreatment conditions. For information about species or tissue type not listed here, contact support at support.acd@bio-techne.com.

Species	Tissue Type	Pathology	Pretreatment Condition
Mouse/Rat	Intestine	Normal	Standard
	Intestine	Tumor	Standard
	Embryo	Normal	Standard
	Brain	Normal	Standard
	Spleen	Normal	Mild
	Eye/Retina	Normal	Standard/Mild
	Liver	Normal	Extended
	Kidney	Normal	Standard

Species	Tissue Type	Pathology	Pretreatment Condition
Human	Breast	Tumor	Standard
	Colon	Tumor	Standard
	Colon	Normal	Standard
	Lung	Tumor	Standard
	Lung	Normal	Standard
	Prostate	Tumor	Standard
	Prostate	Normal	Standard
	Lymph node	Tumor	Mild
	Lymph node	Normal	Mild
	Tonsil	Normal	Mild
	Pancreas	Normal	Standard
	Cervical	Cancer	Standard
	Cervical	Normal	Standard
	Cervical dysplasia	Abnormal	Standard
	Brain	Tumor	Standard
	Brain	Normal	Standard
	Head	Cancer	Standard
	Neck	Cancer	Standard
	Liver	Cancer	Standard
	Kidney	Normal	Standard
	Skin	Normal	Standard
	Melanoma	Tumor	Standard
	Nevus	Benign	Standard
	Placenta	Normal	Standard
	Skin (TMA*)	Normal	Standard
	Breast (TMA)	Normal	Standard
	Melanoma (TMA)	Normal	Standard
	Nevus (TMA)	Benign	Standard
	Stomach (TMA)	Normal	Standard
	Stomach (TMA)	Tumor	Standard
	Cell pellets fixed with 10% NBF	—	Light [†]
	HeLa cells fixed with 10% formaldehyde (ACD controls)	—	Mild

* Tissue Microarray

† If Protease III does not give you good results, try Protease Plus instead.

B

Appendix B. Manual Target Retrieval

Materials required

Materials provided by the Universal Pretreatment Kit	Other Materials and Equipment
<ul style="list-style-type: none"> RNAscope® 10X Target Retrieval Reagents 	<ul style="list-style-type: none"> Prepared slides Distilled water Glass beaker (1 or 2 L) Paper towel or absorbent paper Hot plate, isotemp brand Aluminum foil Thermometer Forceps, large Tissue Tek® Slide Rack Tissue Tek® Staining Dish ImmEdge™ Hydrophobic Barrier Pen

Prepare 1X RNAscope® Target Retrieval Reagents

IMPORTANT! Do not boil the 1X RNAscope® Target Retrieval Reagents more than **15 MIN** before use.

1. Prepare **700 mL** of fresh RNAscope® 1X Target Retrieval Reagents by adding 630 mL distilled water to 1 bottle (70 mL) 10X Target Retrieval Reagents in the beaker. Mix well.
2. Place the beaker containing RNAscope® 1X Target Retrieval Reagents on the hot plate. Cover the beaker with foil, and turn the hot plate on high for **10–15 MIN**.
3. Once the 1X RNAscope® Target Retrieval Reagents reach a mild boil (**98–102°C**), turn the hot plate to a lower setting to maintain the correct temperature. Check the temperature with a thermometer.

Apply RNAscope® Target Retrieval Reagents



1. With a pair of forceps *very slowly* submerge the slide rack containing the slides into the mildly boiling RNAscope® 1X Target Retrieval Reagents solution. Cover the beaker with foil, and boil the slides for the amount of time specified by the table in **Appendix A. Tissue Pretreatment Recommendation** on page 40.
2. Use the forceps to *immediately* transfer the hot slide rack from the RNAscope® 1X Target Retrieval Reagents to the staining dish containing distilled water. Do not let the slides cool in the Target Retrieval Reagents solution.
3. Wash slides 3–5 times by moving the Tissue-Tek® Slide Rack up and down in the distilled water.
4. Wash slides in fresh 100% alcohol, and allow the slides to dry completely at **60°C** for **5 MIN**.
5. Draw the hydrophobic barrier, and continue with miRNAscope™ HD Assay.



Appendix C. Reagent Volume Guidelines

Determine reagent volume

Before starting your experiment, measure the inner edge of the hydrophobic barrier to determine the recommended number of drops needed per slide (see table below).

Size of hydrophobic barrier* (in)	Recommended number of drops per slide	Recommended volume per slide (μL)	Relative template size
0.75" x 0.75" †	4	120	
0.75" x 1.0"	5	150	
0.75" x 1.25"	6	180	

* Hydrophobic barrier measured at inner edge. References in this user manual are for the 0.75" x 0.75" hydrophobic barrier size.

† Recommended hydrophobic barrier size is 0.75" x 0.75". With this barrier size, each probe is sufficient for staining ~20 sections. Larger tissue sections will result in fewer tests.

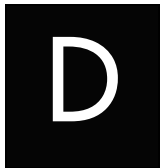

Appendix D. Safety

Chemical safety



WARNING! GENERAL CHEMICAL HANDLING. To minimize hazards, ensure laboratory personnel read and practice the general safety guidelines for chemical usage, storage, and waste provided below, and consult the relevant SDS for specific precautions and instructions:

- Read and understand the Safety Data Sheets (SDSs) provided before you store, handle, or work with any chemicals or hazardous materials. To obtain SDSs, visit <http://www.acdbio.com/technical-support/user-manuals>.
- Minimize contact with chemicals. Wear appropriate personal protective equipment when handling chemicals (for example, safety glasses, gloves, or protective clothing).
- Minimize the inhalation of chemicals. Do not leave chemical containers open. Use only with adequate ventilation (for example, fume hood).
- Characterize (by analysis if necessary) the waste generated by the particular applications, reagents, and substrates used in your laboratory.
- Ensure that the waste is stored, transferred, transported, and disposed of according to all local, state/provincial, and/or national regulations.
- **IMPORTANT!** Radioactive or biohazardous materials may require special handling, and disposal limitations may apply.

Biological hazard safety



WARNING! BIOHAZARD. Biological samples such as tissues, body fluids, infectious agents, and blood of humans and other animals have the potential to transmit infectious diseases. Follow all applicable local, state/provincial, and/or national regulations. Wear appropriate protective equipment, which includes but is not limited to: protective eyewear, face shield, clothing/lab coat, and gloves. All work should be conducted in properly equipped facilities using the appropriate safety equipment (for example, physical containment devices). Individuals should be trained according to applicable regulatory and company/institution requirements before working with potentially infectious materials. Read and follow the applicable guidelines and/or regulatory requirements in the following:

In the U.S.:

- U.S. Department of Health and Human Services guidelines published in Biosafety in Microbiological and Biomedical Laboratories found at www.cdc.gov/biosafety
- Occupational Safety and Health Standards, Bloodborne Pathogens (29 CFR§1910.1030)
- Your company's/institution's Biosafety Program protocols for working with/handling potentially infectious materials
- Additional information about biohazard guidelines is available at www.cdc.gov/

In the EU:

- Check local guidelines and legislation on biohazard and biosafety precaution and refer to the best practices published in the World Health Organization (WHO) Laboratory Biosafety Manual, third edition
- Registration, Evaluation, Authorisation and Restriction of Chemicals (REACH)

Documentation and support

Obtaining SDSs

Safety Data Sheets (SDSs) are available at: www.acdbio.com/technical-support/user-manuals. For the SDSs of chemicals not distributed by Advanced Cell Diagnostics, contact the chemical manufacturer.

Obtaining support

For the latest services and support information, go to: www.acdbio.com/technical-support/support-overview.

At the website, you can:

- Access telephone and fax numbers to contact Technical Support and Sales facilities.
- Search through frequently asked questions (FAQs).
- Submit a question directly to Technical Support.
- Search for user documents, MSDSs, application notes, citations, training videos, and other product support documents.
- Find out information about customer training events.

Contact information

Advanced Cell Diagnostics, Inc.
7707 Gateway Boulevard
Newark, CA 94560
Toll Free: 1-877-576-3636
Direct: 1-510-576-8800
Fax: 1-510-576-8801
Information: info.acd@bio-techne.com
Orders: order.acd@bio-techne.com
Support Email: support.acd@bio-techne.com

Limited product warranty

Advanced Cell Diagnostics, Inc. and/or its affiliate(s) warrant their products as set forth in the ACD General Terms and Conditions of Sale found on the ADC website at www.acdbio.com/store/terms. If you have any questions, please contact Advanced Cell Diagnostics at www.acdbio.com/about/contact.

Headquarters

7707 Gateway Blvd, Newark, CA 94560 Phone 1-510-576-8800 Toll Free 1-877-576-3636

For support, email support.acd@bio-technie.com.

www.acdbio.com

